

Part Number:	SM450204-1	
DESCRIPTION:	Dynamic Speaker	
DRAWN	CJ	12/2/2016
CHECKED	P.D.	12/2/2016
APPROVED	J.S.	12/2/2016
This document contains data proprietary to DB Unlimited. Any use or reproduction, in any form, without prior written permission of DB Unlimited is prohibited. All terms and conditions can be found at www.dbunlimitedco.com		

Top View

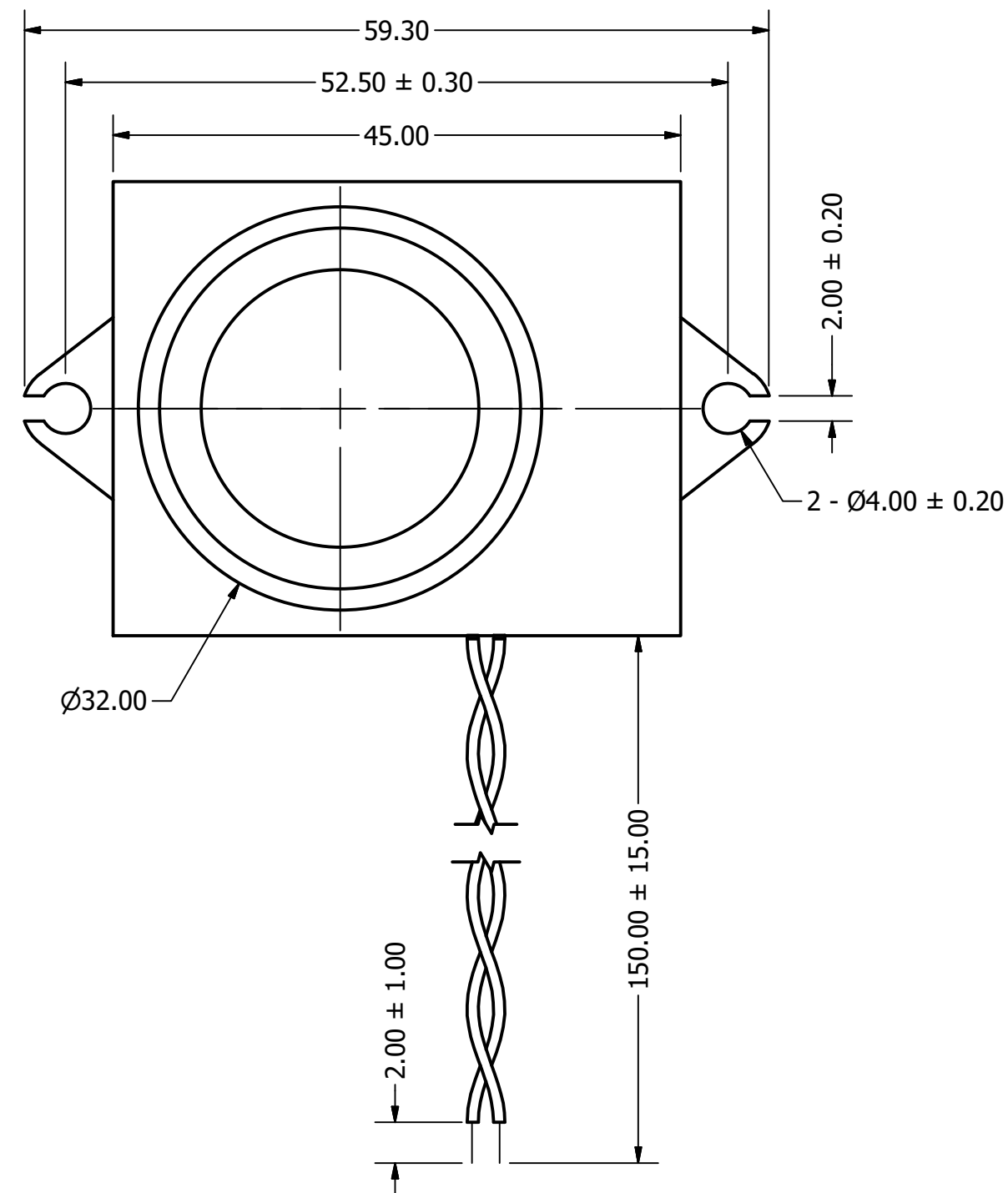

Side View

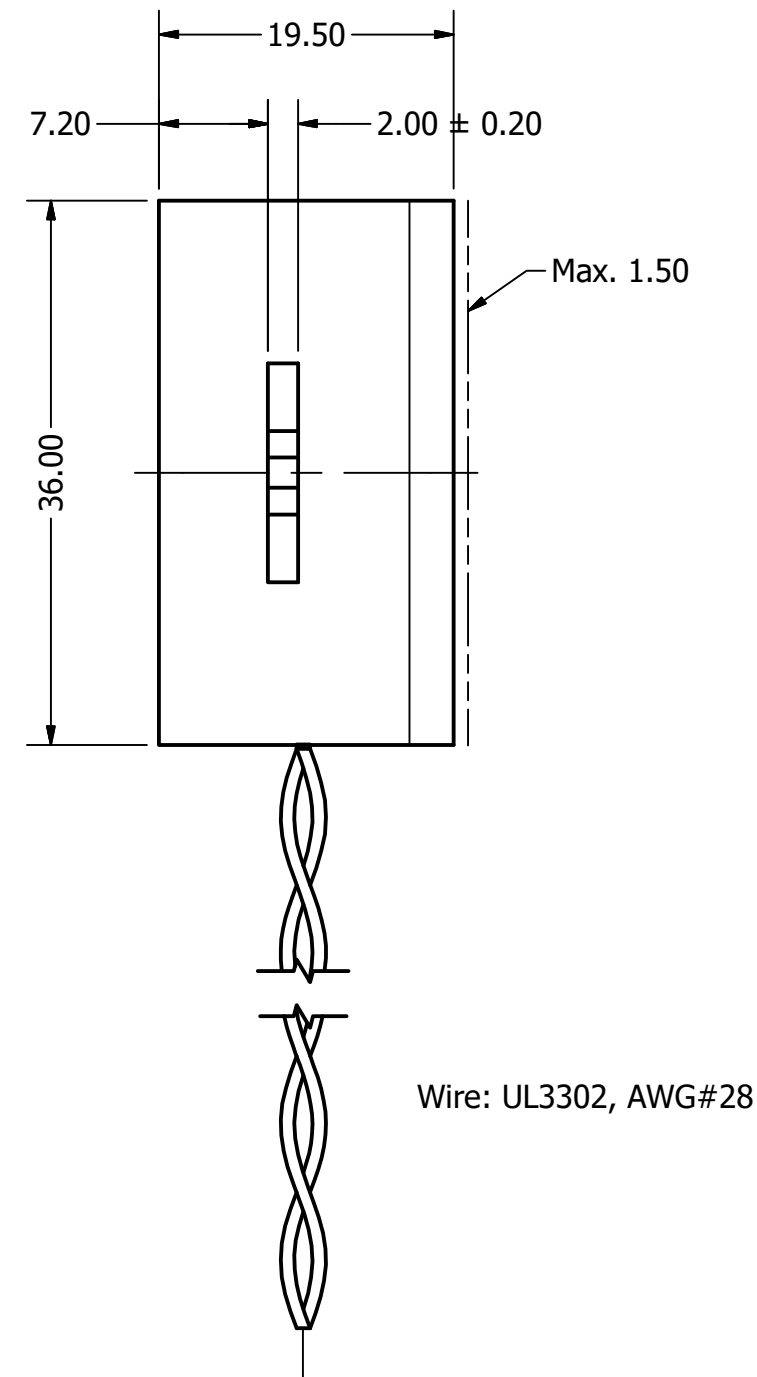

Bottom View

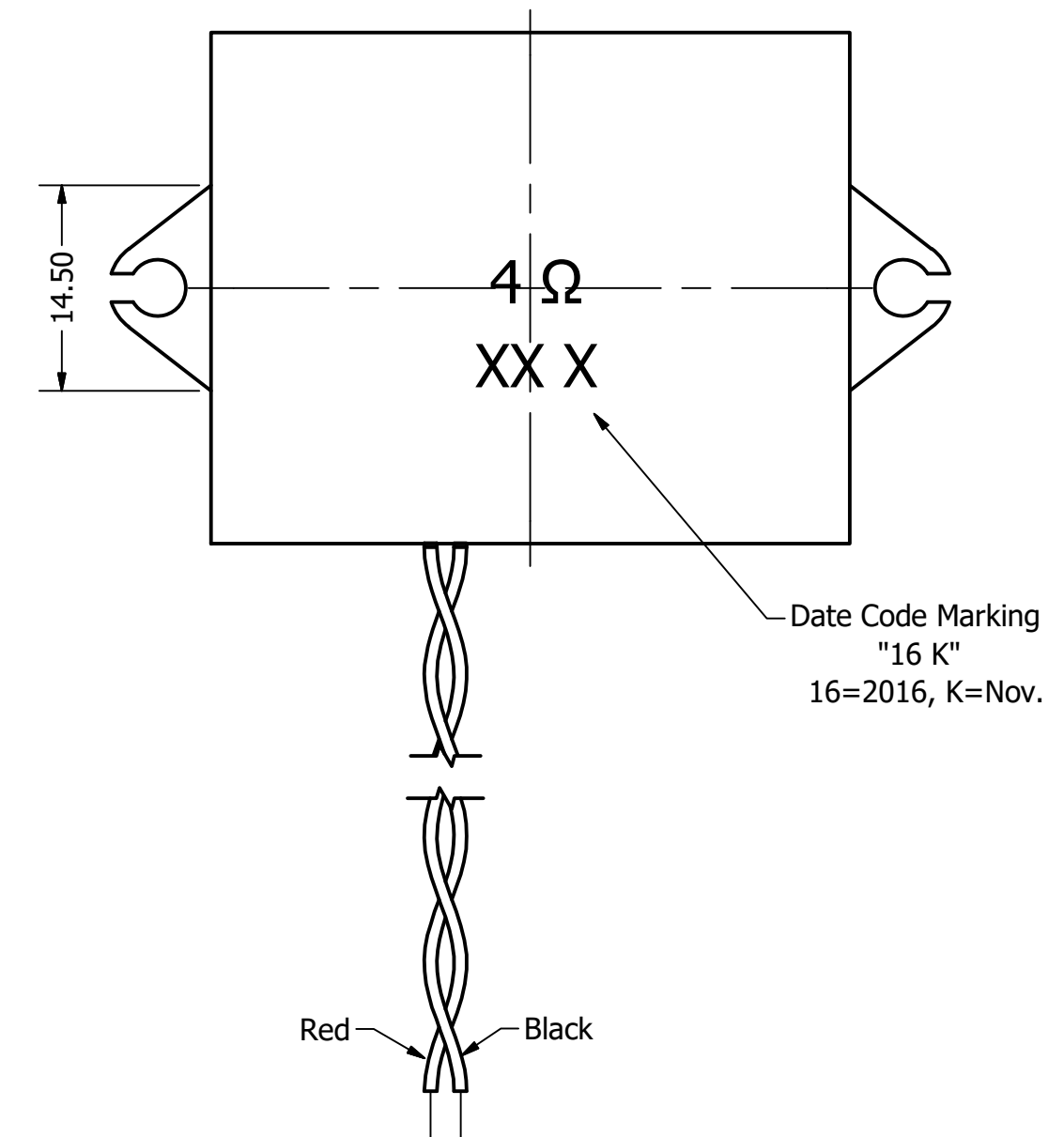

Items	Specifications	Conditions
Sound Pressure Level	88	dB (@ 10cm)
Resonant Frequency	200	Hz
Frequency Range	200 ~ 10,000	Hz
Nominal Power	3	W
Max. Power	5	W
Impedance	4	Ω
Cone Material	Mylar	
Mount Type	Flange Mount	
Storage Temperature	-30 ~ +70	°C
Operating Temperature	-20 ~ +60	°C

REVISION HISTORY			
REV	DESCRIPTION	DATE	APPROVED
	Released from Engineering	12/2/2016	J.S.

NOTES	
1) All dimensions are in mm unless otherwise noted	
2) All tolerances are ± 0.5 mm unless otherwise noted	
3) All parts meet RoHS	
4) Subject to change or redrawn without notice	